

# **GR**Reddy®

## ***GR*Reddy Intercooler Kit**

***Mazda RX-7 Sequential Turbos (FD3S)***



## Mazda RX -7 1993 -96 ( FD3S)

# Installation Manual

Please read the entire manual before installing this kit.

### Application:

Make	Model	Chassis	Year
Mazda	RX -7	FD3S	93 ~ 96

- This **GRddy Front Mount Intercooler Kit** is designed only for the vehicles specified above with 13B-REW engine.

# 1. Parts List

1. Intercooler Core	1
2. 70mm dia. X 70mm Straight Hose	4
3. Intake Tube I-1 70mm dia. Aluminum Elbow #39	1
4. Intake Tube I-2 70mm dia. Aluminum Elbow #40	1
5. Air Duct (Aluminum)	1
6. Rubber Wind Difflector 220mm X 300mm	1
7. 70mm dia. #44 Hose Clamp	8
8. 200mm Wire Tie	5
9. 6mm X 15mm P=1.0 Stainless Blot/Lock Washer	7
10. 6mm Steel Large Flat Washer	6
11. 6mm Stainless Flat Washer	3
12. 6mm Stainless Nut	2

# Parts List Pictorial

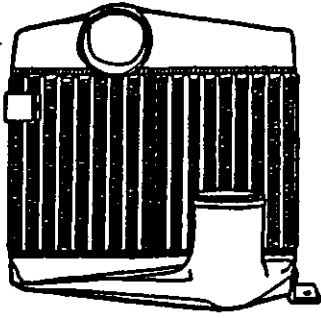

1

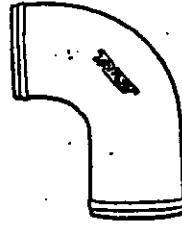

2

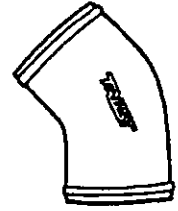

3

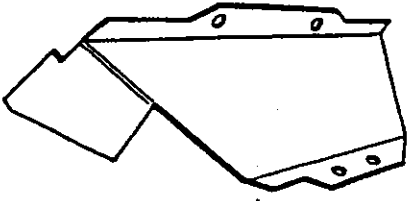

4

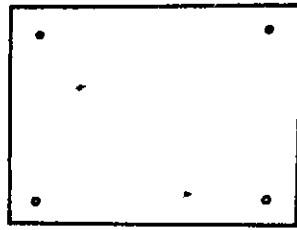

5



6



7

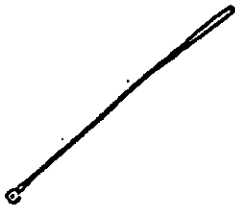

8



9



10



11



12

## 2. Removal of stock components.

- 1.> Fresh Air Duct
- 2.> Air Cleaner Assy.
- 3.> Battery / Carrier
- 4.> Air Hose
- 5.> Bracket
- 6.> Air Separation Tank
- 7.> Intercooler

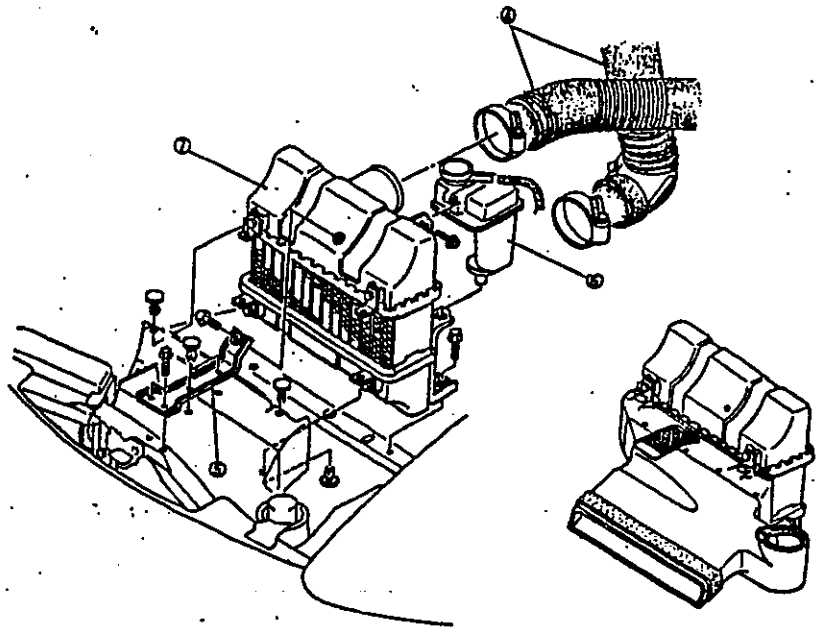
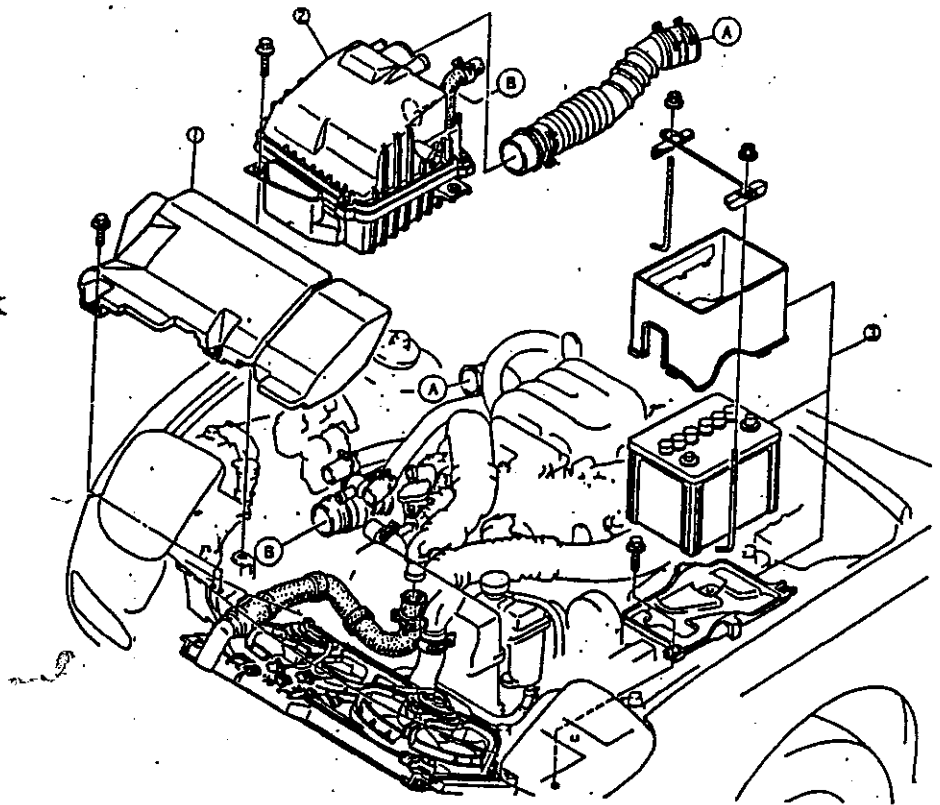

- 2-1 Remove the Battery with the Carrier. (#3)
- 2-2 Remove the Fresh Air Duct. (#1)
- 2-3 Remove the Air Cleaner Assembly. (#2)
- 2-4 Disconnect the Air Hoses and the Air Separation Tank from the Intercooler. (#4, #6)
- 2-5 Remove the Intercooler and the Bracket (#7, #5)
- 2-6 Remove the Intercooler Air Duct from the Intercooler.

### 3. Kit Installation

3-1. Mount the L-Shaped Bracket, that secures the Stock Intercooler to the Intercooler Air Duct, to the Air Duct.

3-2. Cut away the shaded area, from the Air Duct, shown below using a utility knife, and install in the stock location.

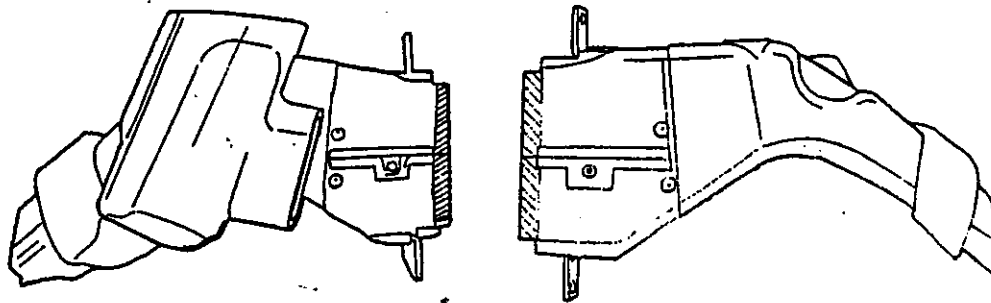

3-3. Bolt the Rubber Air Deflector provided and the L-shaped bracket of the Air Duct to the fixed nut A (shown below) with a bolt.

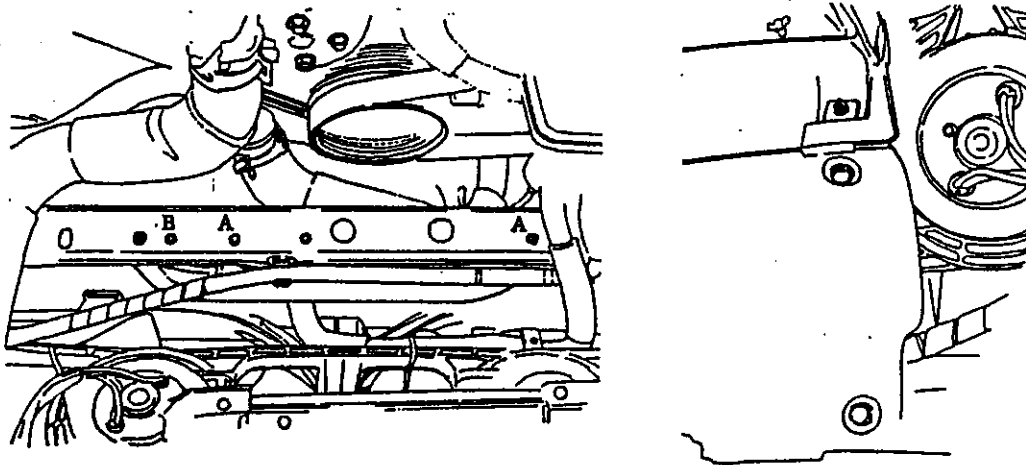

3-4 Set the GReddy Intercooler Core as shown below, and temporarily bolt to the fixed nut B shown in the Fig.3-3 with a 6mm bolt.

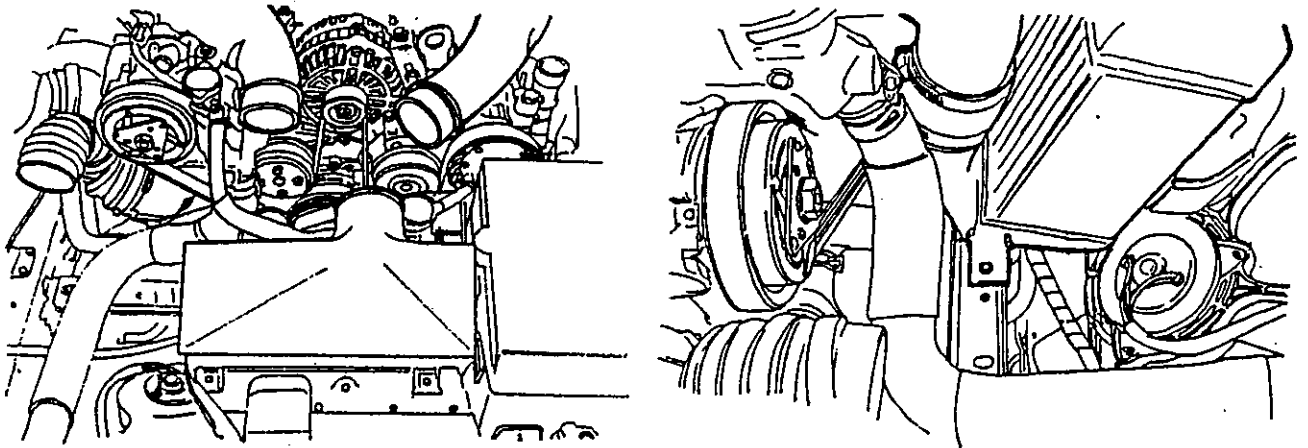

3-5 Mount the Aluminum Air Duct provided to the GReddy Intercooler Core. At this time, tighten the 6mm bolt installed in 3-4.

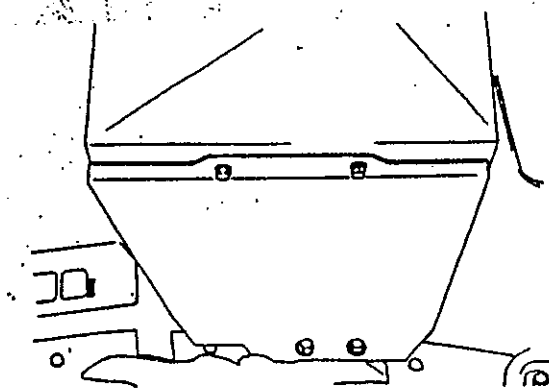

3-6 Install the Air Separation Tank to the bracket shown below reusing the factory bolt.

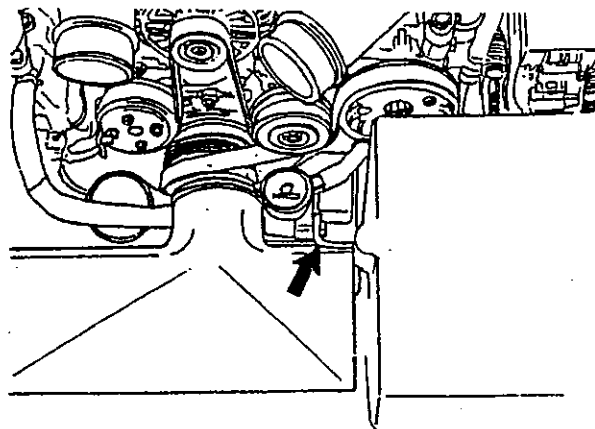



3-7 Connect the Turbine to the Intercooler using the I-1 (90° Aluminum Elbow 70mm dia.), Hose Clamps, and the Hose. Connect the Intercooler to the Throttle with the I-2 (70° Aluminum Elbow 70mm dia.), Hose Clamps, and the Hose.

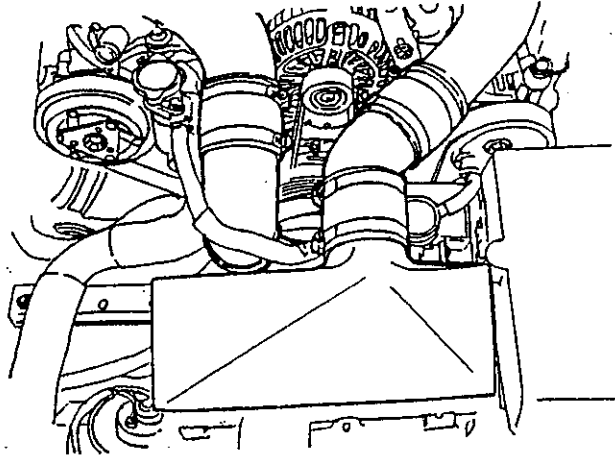

3-8 Cut the shaded area of the factory Air Cleaner Assembly away as shown below. Reinstall the Air Cleaner by reversing the removal procedure.

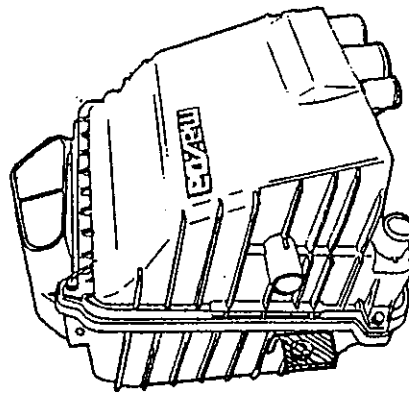

3-9 Reinstall the Battery Carrier and the Battery Box.

3-10 Inspect all plumbing, reconnect the Battery, Connector and start the engine. At idel, check for air leakages and noises to make necessary adjustments.

Kit Installation is now complete.